

# PURE THEATRE

INSTALLATION

OPERATION

SETUP

PROGRAM IR REMOTE

FACTORY RESET

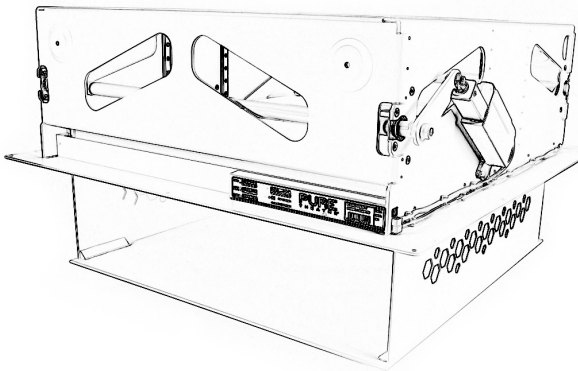

MODELS:  
CR60 | CR70 | CR90

## Projector Lift User Guide

# CONTENTS

Checklist .....	1
Parts .....	2
Installation .....	3-7
Navigating the remote .....	8
Navigating the menu .....	9
Learning IR - To use any remote control.....	10
Com Port - RS232 to Control Projector .....	11
Input Port - 12v Trigger or contact Closure.....	12
Output Port - 12v Trigger or IR Emitter.....	13
Reboot .....	14
Factory Reset.....	15
Notes .....	16-17

---

# CHECKLIST

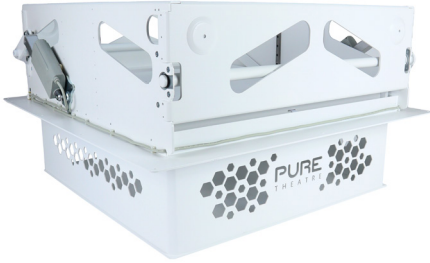

PROJECTOR LIFT



POWER SUPPLY



TRIGGER CABLE



RS232 CABLE



INFRA-RED REMOTE

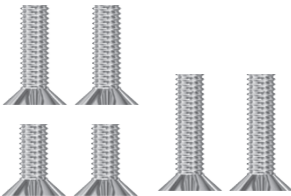

PROJECTOR TRAY SCREWS  
[Mixed Sizes]



SCREW COVERS

# PARTS

LIFT MECHANISM



MOUNTING SCREWS



PROJECTOR MOUNTING TRAY



PROJECTOR HOUSING



## PRIOR TO INSTALLATION

**IMPORTANT :** Release projector housing and tray prior to installation



### STEP 1.

Place lift on shipping box, then connect power and lower using remote control.

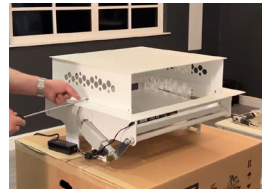

### STEP 2.

Remove the retaining screws, located on either side of the projector housing.



### STEP 3.

Separate the lift mechanism from the projector housing.



### STEP 4.

Remove projector mounting tray



## **STEP 1.** Find Joists, Pipes & Cables

Find the approximate position for your projector and then locate and mark the position of any joists, wiring and plumbing.

To aid installation a wood/metal sensor is recommended. Available from most DIY stores



## **STEP 2.** Mark Out Position\*

Now you have the joists positions marked, measure the exact position for the projector lift and mark out the cut-out by checking the dimension sheet included.



## **STEP 3.** Cut Slot

Cut out ceiling slot along the template line, taking care to keep as close to the line as possible.



## **STEP 5.** Install Transformer

Place the mains transformer into the ceiling cavity and connect to the nearest suitable mains power supply. Allow the 24v plug to hang down for easy connection to the lift.



## **STEP 6.** Install Projector Lift Mechanism

Raise the lift mechanism up to the ceiling and connect the power supply.

Note. The LEDs on the lift should both light RED, then go to GREEN and YELLOW, and then OFF



## **STEP 7.** Secure mechanism to joists

Once in place, secure the lift mechanism. Firstly secure the lift with the outer frame screws. Then screw the front and rear plate of the projector lift into the joists.

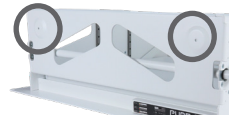

## **STEP 8.** Test Mechanism + Install Cables

Test mechanism up and down with remote control then leave in the down position to allow projector housing to be mounted.

Install the projector power and AV cables and leave hanging down approximately 300mm.



## STEP 9. Mount Projector

Mount the projector to the projector tray. Ensure the projector is upside down. *Ensure arrow points to the front of projector.*

**Note:** See page 6-7 for information about projector mounting and leveling



## STEP 10. Install Projector into Mechanism

Raise the projector and tray up to the lift mechanism and slide in. Then connect all power and AV cables to the projector.



## STEP 11. Install Projector Housing

Once power and AV cables are connected lift the projector housing up into the lift mechanism and fit retaining screws, on either side.

This will secure the projector housing to the lift mechanism.



## STEP 12. Secure And Test

Finally tighten all screws into ceiling.

[Fit screw covers once you have tested your installation.]

### **Your lift is now ready to use.**

Please read the following pages for operating instructions and programming options.

# INSTALLATION

## MOUNTING PROJECTOR

Different projectors require different screws when fitting to the projector mounting tray, we supply a range of screws please see manufacturers guidelines for the correct screws.

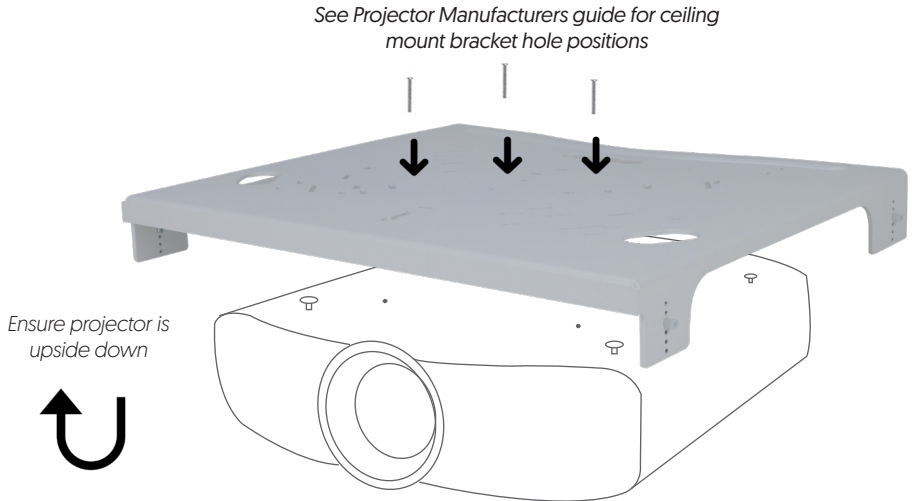

## HOOKING THE TRAY INTO THE MECHANISM

The projector mechanism on the CR50 has been designed for easy installation and features a hook in tray. Inside the lift mechanism you will see arms on the left and right with the following shaped slots.



Firstly hook the tray into the back slot and push backwards. Next hook into the front slot pushing upward and then pull forward until it drops into point 5.

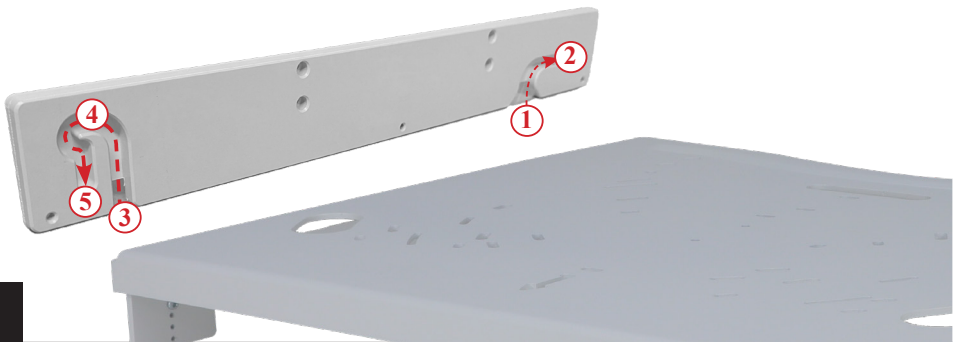

## PROJECTOR ADJUSTMENTS

There are several adjustments that can be made to the CR50 Projector lift to accommodate different projectors.

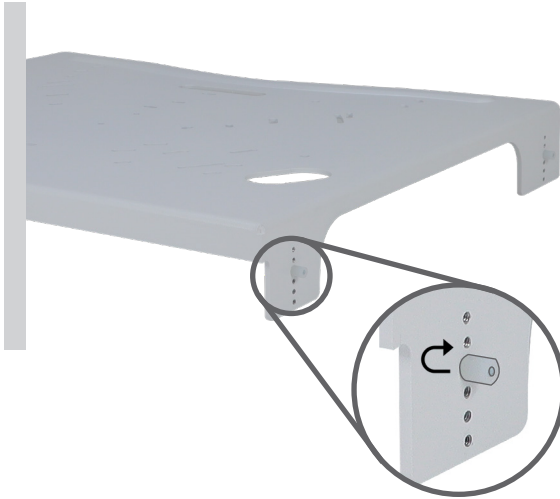

### COARSE ADJUSTMENT

The projector mounting tray is adjustable for projectors with different heights. On all four legs there are screw positions. Lower or higher the screws dependant on your projector height.

These screws can also be used for tilting the projector. Simply set the front screws to a lower position than the rear.

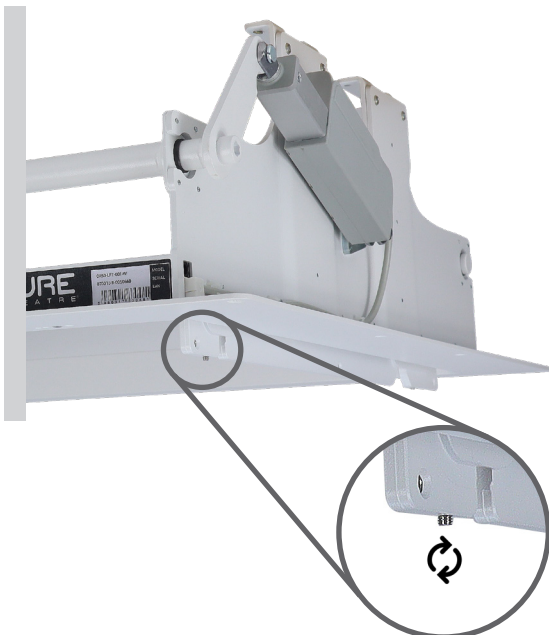

### FINE TUNING

For fine tuning (Less than 10mm) the projector mechanism is fitted with lug screws. These can be adjusted, using the provided Allen key.

This can be used to level the projector once installed.

# NAVIGATING THE REMOTE

Once your lift is **correctly installed** with all packaging removed and **power has been established**, simply press the Up & Down buttons on the remote control to operate the lift.

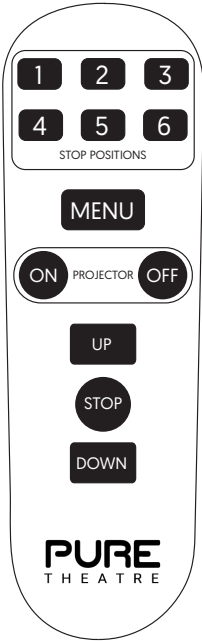

The **NUMBER** buttons are used to move the lift directly to your preferred stop positions and to navigate the menu.

The **MENU** button puts the lift into programming mode to configure several options.

Turns the Projector **ON** or **OFF** when connected by RS232.





Moves the projector lift **UP**.

**STOP**s movement of the projector lift.

Moves the projector lift **DOWN**.





## THE CONTROL PANEL



-  **Mode** - An LED that indicates the lift's mode.
-  **Status** - An LED that indicates the lift's status.
-  **Infrared Receiver** - To receive commands from the IR remote control.
-  **Program Button** - Used to configure the lift.

# NAVIGATING THE MENU

The MENU is used to configure your Pure Theatre Projector Lift.  
Each configurable option has an associated Number and LED Colour.

- 1** **InfraRed Learning Mode** →  page 10  
Allows your lift to be controlled from any InfraRed Remote.  
Why not use a Projector Remote to raise and lower your lift.
- 2** **RS232 - COM PORT** →  page 11  
Send Commands to turn your projector ON | OFF with RS232  
OR Receive commands from a Control system. eg Control4 or RTI.
- 3** **OUTPUT PORT** →  page 13  
12v trigger OUTPUT for controlling devices with a 12V input  
OR InfraRed OUT for controlling projectors with an IR Emitter.
- 4** **INPUT PORT** →  page 12  
12v trigger INPUT to automatically move the lift UP | DOWN  
OR Contact Closure INPUT when using a wall switch or relay.

The projector lift can **learn commands** from the majority of domestic remote controls, allowing your TV or projector remote to control the lift.

Programming a new remote will **NOT** disable the PureTheatre™ IR Remote.

## PROGRAMMING INFRARED REMOTE CONTROL

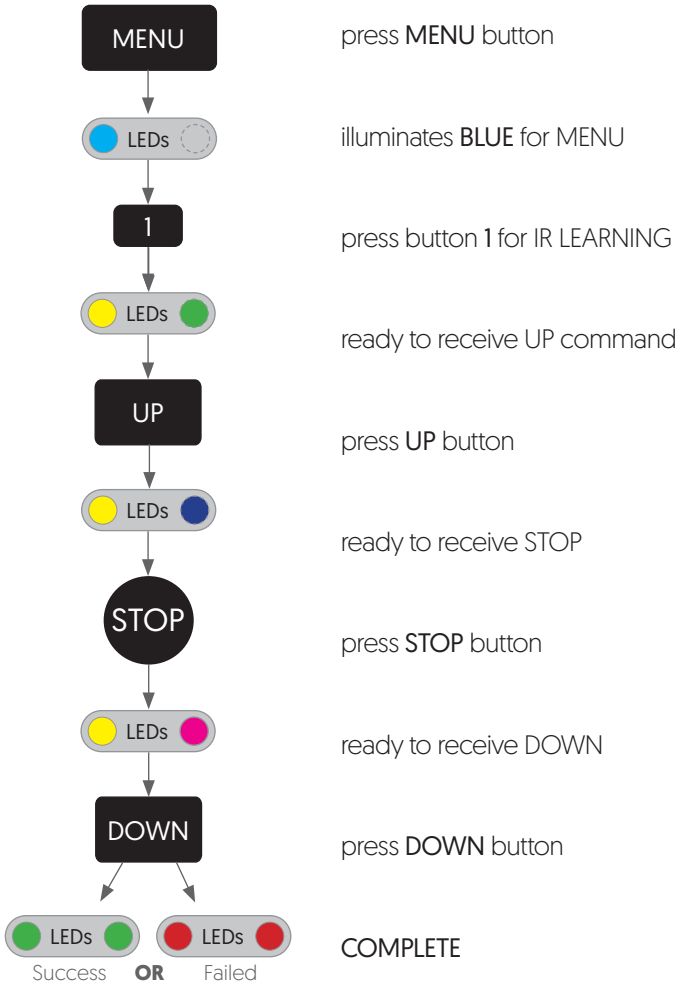

The RS232-COM port is used to automate your system and can be used as in INPUT or OUTPUT:

- **INPUT** - to control your lift using your home automation system [ UP / DOWN etc. See page 12]
- **OUTPUT** - the lift will send commands to turn your projector ON | OFF when the lift goes up and down. Simply choose your projector from the list below.

Choose how you want the RS232-COM port to operate from the chart below, then go ahead and configure by entering the 3 digit code using the Pure Theatre Remote Control.

RS232 SETUP	CODE		
	1st	2nd	3rd
CONTROL SYSTEM	1	1	1
OPTOMA	1	1	2
PANASONIC	1	1	3
SONY	1	1	4
EPSON	1	1	5
JVC	1	2	1
BENQ	1	2	2
NEC	1	2	3
INFOCUS	1	2	4



A **12 volt trigger** allows the projector, upon power up and power down, to automatically drop and raise a motorized lift. They are an industry-standard method for integrating complex audio and video systems.

**Contact closure** is a way to interface standard switches, relays or PIR's into a lighting control system. They trigger an event within the control system.

INPUT TYPE	CODE		
	1st	2nd	3rd
12V TRIGGER	2	1	1
CONTACT CLOSURE	2	1	2

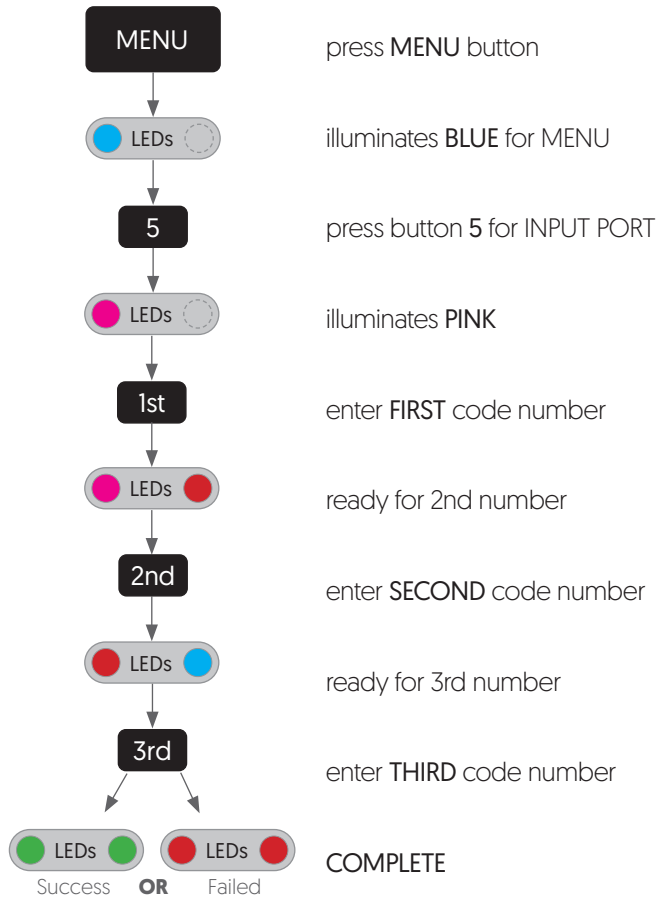

# CONFIGURE OUTPUT PORT **12v** trigger | **IR** emitter

The OUTPUT port can be configured to do one of the following:

- OUTPUT a 12v trigger signal to turn remote devices ON/OFF
- OUTPUT IR commands to turn your projector ON / OFF\*

Choose how you want the OUTPUT port to operate from the chart below then go ahead and configure the lift using the Pure Theatre IR Remote Control.

OUTPUT SETUP	CODE		
	1st	2nd	3rd
12 V OUTPUT	1	1	1
OPTOMA	1	1	2
PANASONIC	1	1	3
SONY	1	1	4
EPSON	1	1	5
JVC	1	2	1
BENQ	1	2	2
NEC	1	2	3
INFOCUS	1	2	4

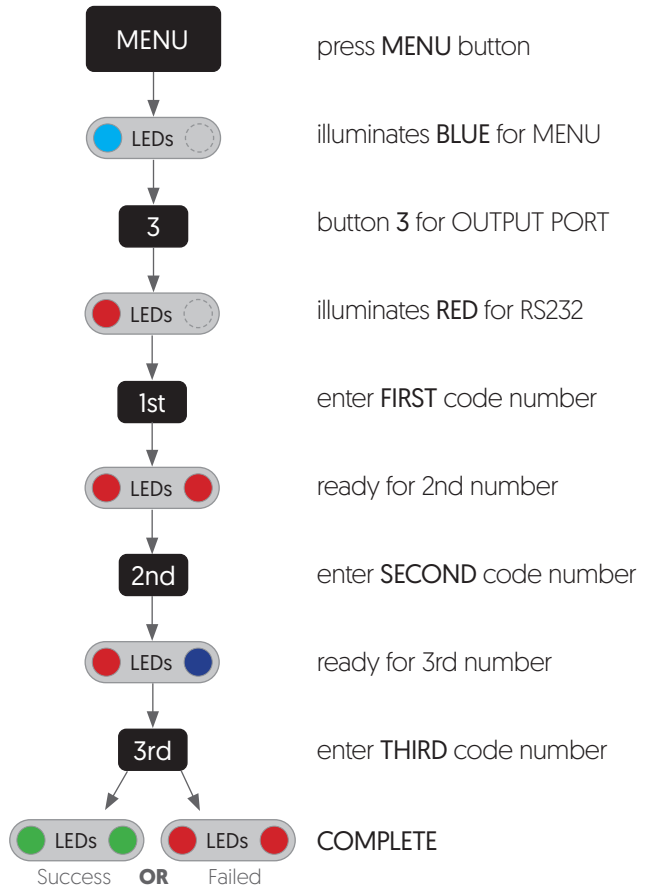

\*Requires additional IR emitter not included

# REBOOT

A **reboot** will restart the controller without altering any settings.



The system will now go through the reboot sequence and lights will flash through all colours.

# FACTORY RESET

A **factory reset** will remove all stored IR commands restoring it back to factory default.

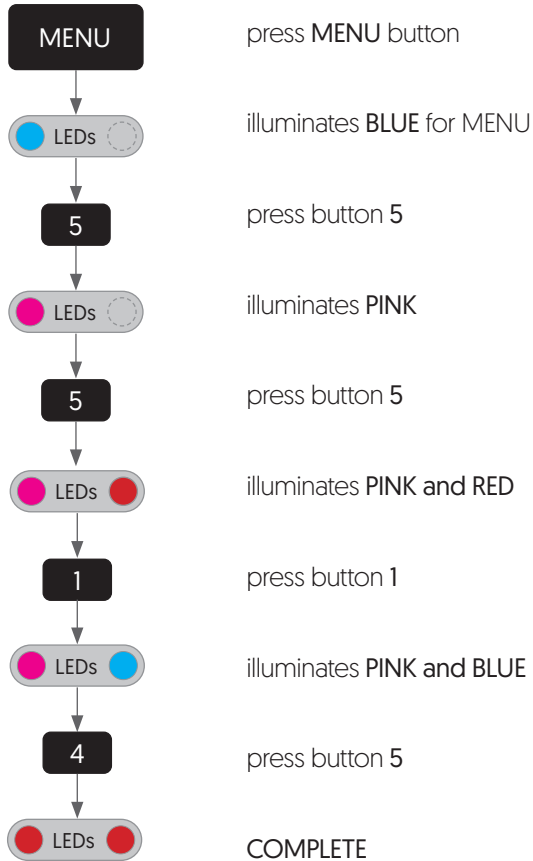





---

supplied by

The logo for Pure Theatre is centered within a light gray rectangular frame. The word "PURE" is written in a large, bold, black, sans-serif font. Below it, the word "THEATRE" is written in a smaller, black, sans-serif font, with each letter spaced out.

**PURE**  
T H E A T R E

[www.puretheatre.com](http://www.puretheatre.com)

---