

RevNo	Revision note	Date	Signature	Checked
-------	---------------	------	-----------	---------

Side View

Rear View

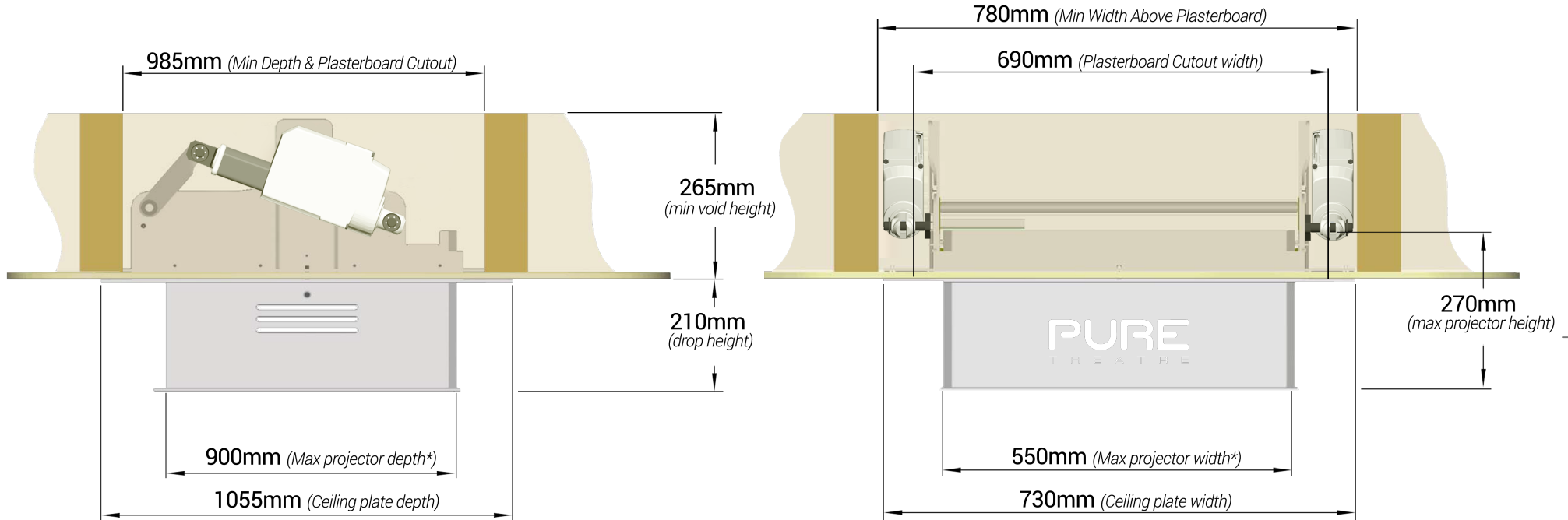

Itemref	Quantity	Title/Name, designation, material, dimension etc			Article No./Reference	
Designed by CAP	Checked by CAP	Approved by - date 07/12/2017	File name CRInstallation.dwg	Date 07/12/2017	Scale NTS	
PureTheatre®			CR90 Dimensions			
			Revision 2b		Edition 2b	Sheet 1/1